

900 series door screen

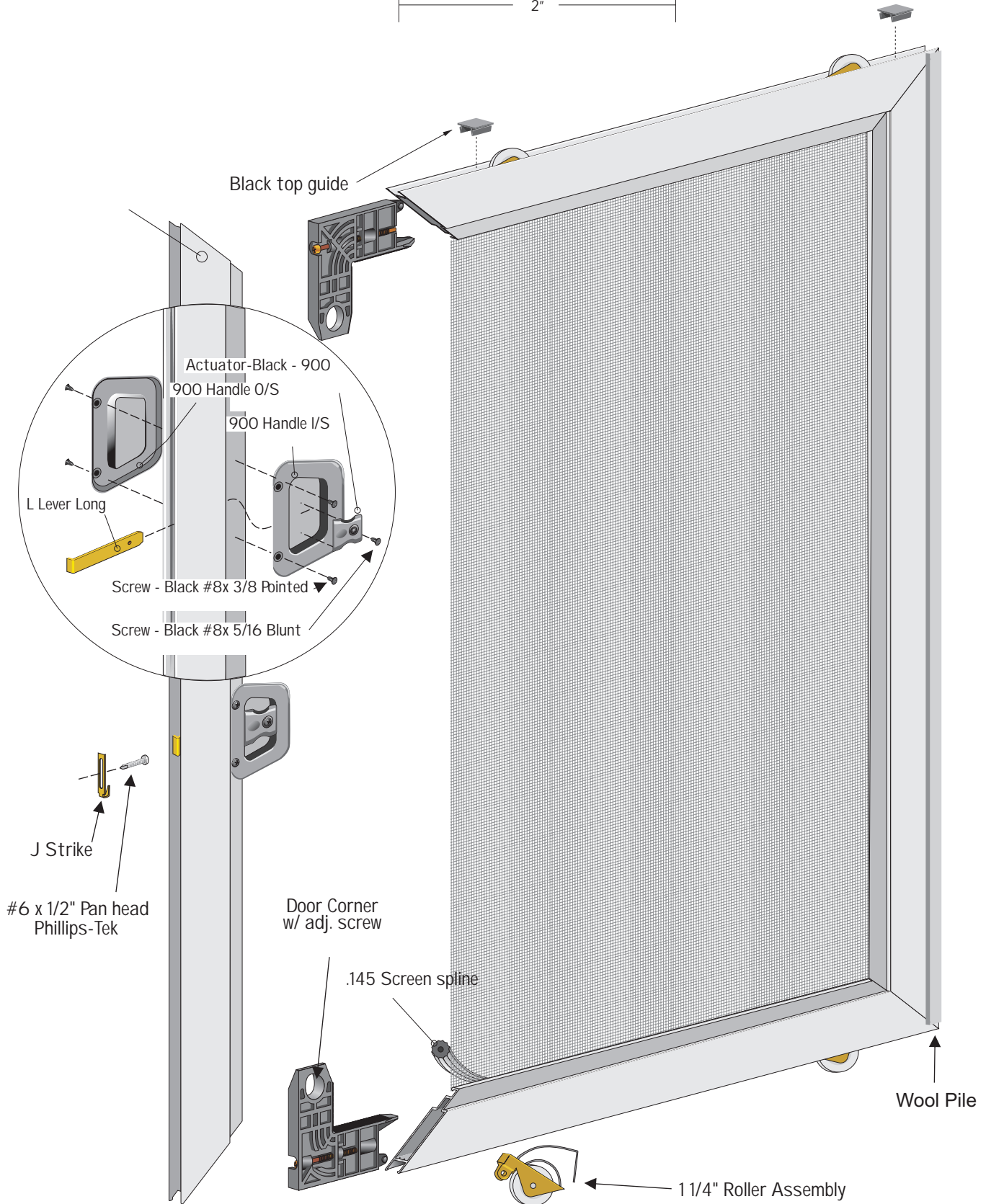

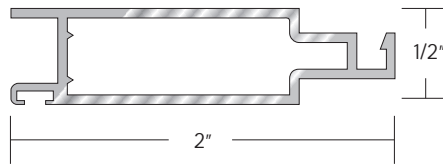

Lic. #223-02 TE-SC-OC-2520CQ

4625 CHENNAULT BEACH RD. ■ MUKILTEO, WA 98275

(206) 623-6141 ■ (425) 347-0947 ■ (206) 622-3497 ■ Fax (206) 622-6933

900 SERIES PATIO SCREEN DOOR

2 X 1/2 EXTRUDED ALUMINUM

WHITE, ALMOND, CLAY, ADOBE, TAN, BRONZE, BLACK, CLEAR ANODIZED

NET PRICES

SPECIAL SIZES:

UP TO 37 X 82	94.01
UP TO 49 X 82	103.49
UP TO 61 X 82	112.97

OVERSIZE HEIGHTS UP TO 96"	26.56
OVER 96"	3.16 PER INCH

CROSSBAR SET	31.21
STEEL WHEELS	21.67
ASTRAGAL (BLACK VINYL)	16.01

SCREEN MESH OPTIONS, GRILLES, TRACKS - SEE BELOW



Lic. #223-02 TE-SC-OC-2520CQ

4625 CHENNAULT BEACH RD. ■ MUKILTEO, WA 98275

(206) 623-6141 ■ (425) 347-0947 ■ (206) 622-3497 ■ Fax (206) 622-6933

ULTRAVUE MESH ADD ON

NET PRICES

	24	30	36	48	60
24	6.48	7.29	8.10	9.72	11.34
30	7.29	8.10	8.91	10.53	12.15
36	8.10	8.91	9.72	11.34	12.96
42	8.91	9.72	10.53	12.15	13.77
48	9.72	10.53	11.34	12.96	14.58
54	10.53	11.34	12.15	13.77	15.39
60	11.34	12.15	12.96	14.58	17.52
66	12.15	12.96	13.77	15.39	18.40
72	12.96	13.77	14.58	17.52	19.27
78	13.77	14.58	15.39	18.40	22.91
84	14.58	15.39	17.52	19.27	23.90
90	15.39	17.52	18.40	22.91	24.90
96	17.52	18.40	21.91	23.90	40.56

RECOMMEND CROSSBAR BELOW DARK LINE

ADD 2.00 FOR WICKET	ADD 4.00 FOR DOUBLE WICKET
---------------------	----------------------------



Lic.#223-02 TE-SC-OC-2520CQ

4625 CHENNAULT BEACH RD. ■ MUKILTEO, WA 98275

(206) 623-6141 ■ (425) 347-0947 ■ (206) 622-3497 ■ Fax (206) 622-6933

PET / SUN MESH ADD ON

NET PRICES

	36	48	60
24	15.30	18.36	21.42
30	16.83	19.89	22.95
36	18.36	21.42	24.48
42	19.89	22.95	26.01
48	21.42	24.48	27.54
54	22.95	26.01	29.07
60	24.48	27.54	36.24
66	26.01	29.07	38.05
72	27.54	36.24	39.86
78	29.07	38.05	51.20
84	36.24	39.86	53.42
90	38.05	51.20	55.65
96	48.97	53.42	89.89

RECOMMEND CROSSBAR BELOW DARK LINE

ADD 3.00 FOR WICKET	ADD 6.00 FOR DOUBLE WICKET
---------------------	----------------------------



Lic. #223-02 TE-SC-OC-2520CQ

4625 CHENNAULT BEACH RD. ■ MUKILTEO, WA 98275

(206) 623-6141 ■ (425) 347-0947 ■ (206) 622-3497 ■ Fax (206) 622-6933

ALUMINUM MESH ADD ON

NET PRICES

	24	30	36	48	60
24	13.63	15.34	17.04	20.45	23.86
30	15.34	17.04	18.74	22.15	25.56
36	17.04	18.74	20.45	23.86	27.26
42	18.74	20.45	22.15	25.56	28.97
48	20.45	22.15	23.86	27.26	30.67
54	22.15	23.86	25.56	28.97	32.38
60	23.86	25.56	27.26	30.67	41.40
66	25.56	27.26	28.97	32.38	43.47
72	27.26	28.97	30.67	41.40	45.54
78	28.97	30.67	32.38	43.47	58.79
84	30.67	32.38	41.40	45.54	61.34
90	32.38	41.40	43.47	58.79	63.90
96	41.40	43.47	56.23	61.34	97.66

RECOMMEND CROSSBAR BELOW DARK LINE

ADD 4.00 FOR WICKET	ADD 8.00 FOR DOUBLE WICKET
---------------------	----------------------------



Lic. #223-02 TE-SC-OC-2520CQ

4625 CHENNAULT BEACH RD. ■ MUKILTEO, WA 98275

(206) 623-6141 ■ (425) 347-0947 ■ (206) 622-3497 ■ Fax (206) 622-6933

ALLERGY / VIRUS GUARD MESH ADD ON

NET PRICES

	24	30	36	48	60
24	16.32	18.36	20.40	24.48	28.56
30	18.36	20.40	22.44	26.52	30.60
36	20.40	22.44	24.48	28.56	32.64
42	22.44	24.48	26.52	30.60	34.68
48	24.48	26.52	28.56	32.64	36.72
54	26.52	28.56	30.60	34.68	38.76
60	28.56	30.60	32.64	36.72	50.40
66	30.60	32.64	34.68	38.76	52.92
72	32.64	34.68	36.72	50.40	55.44
78	34.68	36.72	38.76	52.92	66.24
84	36.72	38.76	50.40	55.44	69.12
90	38.76	50.40	52.92	66.24	72.00
96	50.40	52.92	63.36	69.12	84.24

RECOMMEND CROSSBAR BELOW DARK LINE

ADD 6.00 FOR WICKET	ADD 12.00 FOR DOUBLE WICKET
---------------------	-----------------------------



Lic. #223-02 TE-SC-OC-2520CQ

4625 CHENNAULT BEACH RD. ■ MUKILTEO, WA 98275

(206) 623-6141 ■ (425) 347-0947 ■ (206) 622-3497 ■ Fax (206) 622-6933

BRONZE WIRE MESH ADD ON

NET PRICES

	36	48	60
24	28.32	33.98	39.65
30	31.15	36.82	50.94
36	33.98	47.54	63.46
42	44.15	50.94	67.42
48	47.54	63.46	71.39
54	50.94	67.42	75.35
60	54.34	71.39	79.32
66	57.73	75.35	96.64
72	71.39	79.32	101.24
78	75.35	96.64	105.85
84	79.32	101.24	135.94
90	96.64	105.85	141.60
96	101.24	110.45	147.26

RECOMMEND CROSSBAR BELOW DARK LINE

ADD 8.00 FOR WICKET	ADD 16.00 FOR DOUBLE WICKET
---------------------	-----------------------------



Lic.#223-02 TE-SC-OC-2520CQ

4625 CHENNAULT BEACH RD. ■ MUKILTEO, WA 98275

(206) 623-6141 ■ (425) 347-0947 ■ (206) 622-3497 ■ Fax (206) 622-6933

HEAVY DUTY EXPANDED METAL GRILLES FOR SLIDING SCREEN DOORS CLEAR, BRONZE, WHITE, TAN

NOMINAL SIZE	ACTUAL TIP TO TIP	ACTUAL BODY SIZE	COST	ADD TO INSTALL
30 X 33	30 X 33-3/8	27 X 33-3/8	68.37	25.00
36 X 33	36 X 33-3/8	33 X 33-3/8	68.37	25.00
48 X 33	48 X 33-3/8	45 X 33-3/8	82.91	25.00
60 X 33	60 X 33-3/8	57 X 55-3/8	94.74	25.00

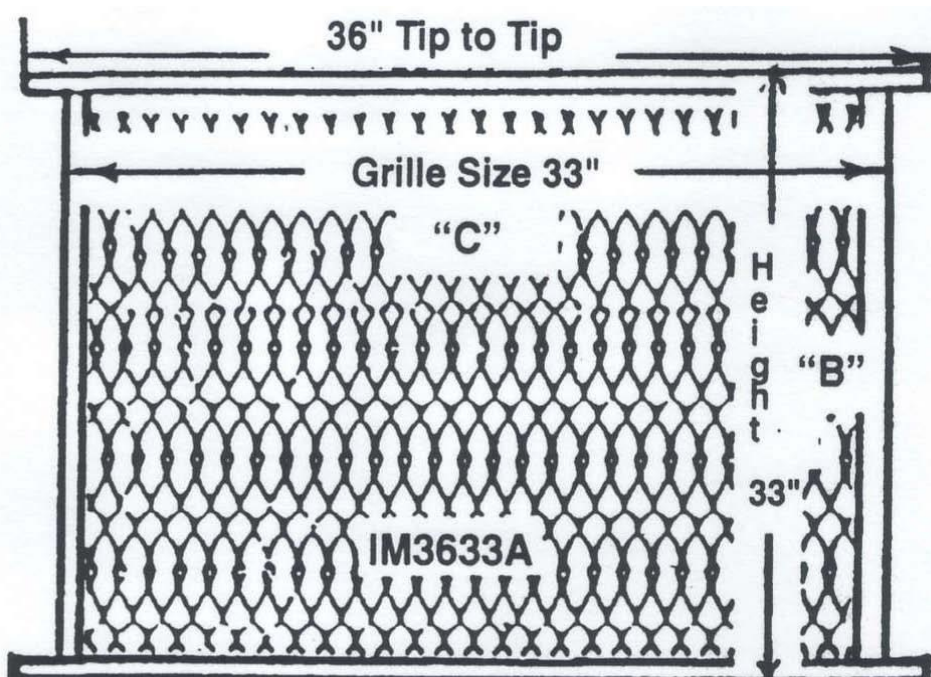



Lic. #223-02 TE-SC-OC-2520CQ

4625 CHENNAULT BEACH RD. ■ MUKILTEO, WA 98275







(206) 623-6141 ■ (425) 347-0947 ■ (206) 622-3497 ■ Fax (206) 622-6933

SLIDING SCREEN DOOR TRACKS

.050 EXTRUDED ALUMINUM

WHITE, BRONZE, CLEAR ANODIZED, TAN

NET PRICES

		12' LENGTH	6' LENGTH
3601 5/8 X 1/2 CHANNEL		46.77	28.39
		81" LENGTH 38.63	
3602 5/8 X 1 CHANNEL		55.29	32.65
3603 5/8 X 1/2 DOUBLE CHANNEL		62.43	36.22
3604 5/8 X 1 DOUBLE CHANNEL		74.13	42.07
3606 SINGLE BOTTOM TRACK		44.69	27.35
3607 DOUBLE BOTTOM TRACK		53.51	31.76