

1/4 FLAT SCREENS

WINDOW SCREEN WITH SPRINGS

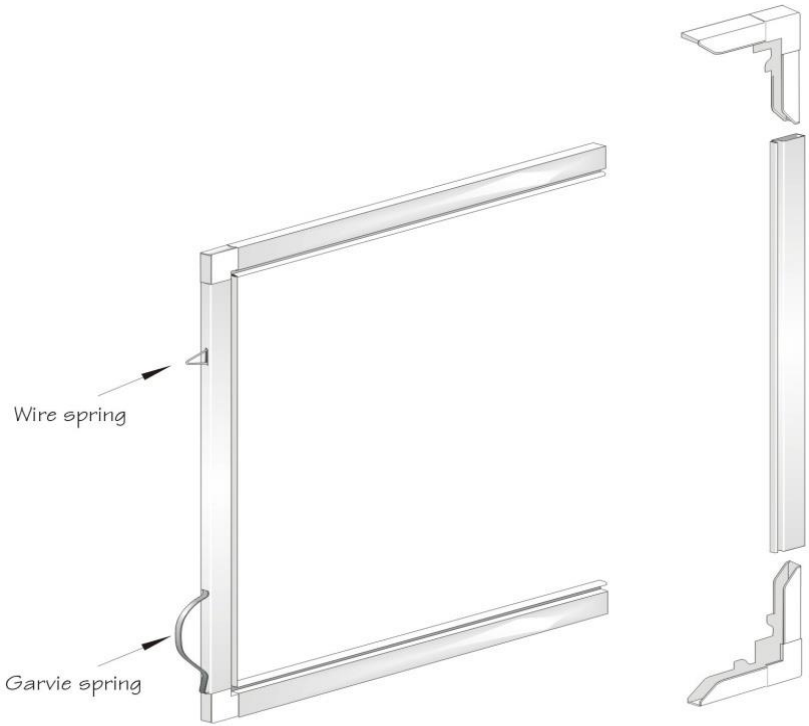

WINDOW SCREEN WITH PLUNGERS

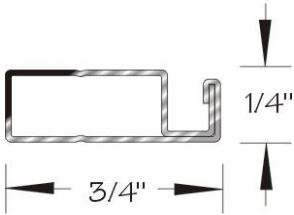
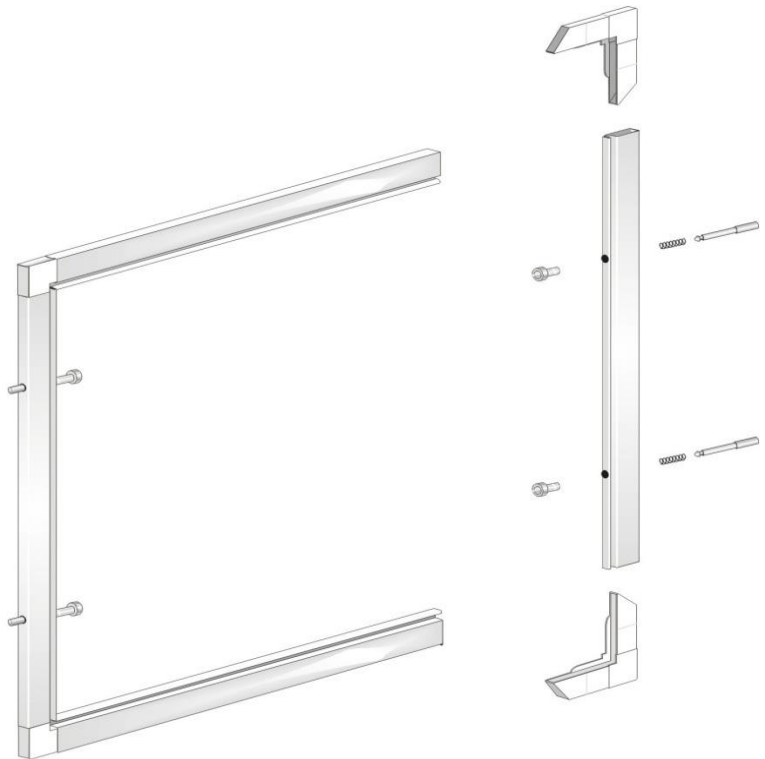
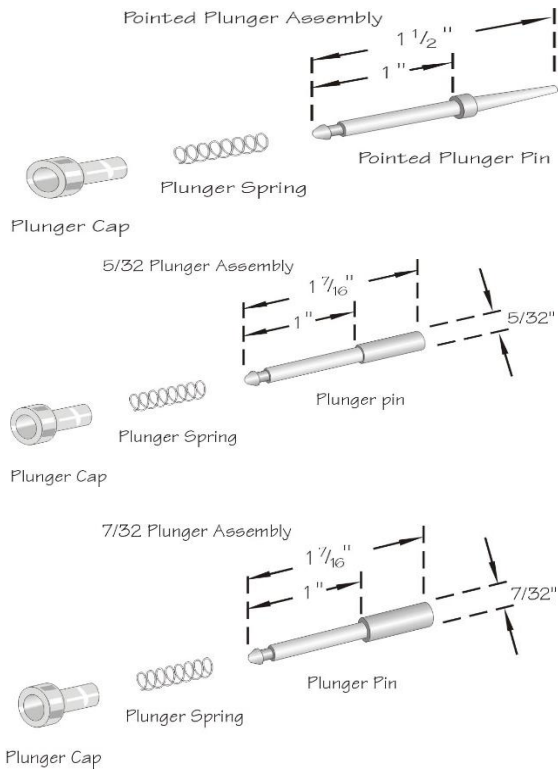



Lic. #223-02 TE-SC-OC-2520CQ

4625 CHENNAULT BEACH RD. ■ MUKILTEO, WA 98275

(206) 623-6141 ■ (425) 347-0947 ■ (206) 622-3497 ■ Fax (206) 622-6933

FLAT SCREENS

ALUMINUM FRAMES - FIBERGLASS MESH - MITERED CORNERS - NET PRICES

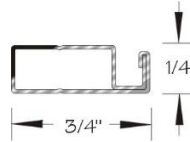

1/4

WHITE

GRAY

BRONZE

	24	30	36	42	48	54	60
24	14.50	16.31	18.12	19.93	21.74	23.56	23.56
30	16.31	18.12	19.93	21.74	23.56	25.37	27.18
36	18.12	19.93	21.74	23.56	25.37	27.18	30.05
42	19.93	21.74	23.56	26.29	28.17	30.05	31.93
48	21.74	23.56	25.37	28.17	30.05	31.93	33.80
54	23.56	25.37	27.18	30.05	31.93	33.80	35.68
60	25.37	27.18	30.05	31.93	33.80	35.68	41.52
66	27.18	30.05	31.93	33.80	35.68	41.52	43.60
72	28.99	31.93	33.80	35.68	37.56	43.60	52.80

RECOMMEND CROSSBAR

CROSSBAR

2.00 PER FT

SLIDE LOCKS / WIRE SPRINGS

1.50 EACH

PLUNGERS

2.50 EACH

NON 90 DEGREE CORNER

55.00 EACH

SCREEN MESH OPTIONS - SEE PAGES BELOW



Lic. #223-02 TE-SC-OC-2520CQ

4625 CHENNAULT BEACH RD. ■ MUKILTEO, WA 98275

(206) 623-6141 ■ (425) 347-0947 ■ (206) 622-3497 ■ Fax (206) 622-6933

ULTRAVUE MESH ADD ON

NET PRICES

	24	30	36	48	60
24	6.48	7.29	8.10	9.72	11.34
30	7.29	8.10	8.91	10.53	12.15
36	8.10	8.91	9.72	11.34	12.96
42	8.91	9.72	10.53	12.15	13.77
48	9.72	10.53	11.34	12.96	14.58
54	10.53	11.34	12.15	13.77	15.39
60	11.34	12.15	12.96	14.58	17.52
66	12.15	12.96	13.77	15.39	18.40
72	12.96	13.77	14.58	17.52	19.27
78	13.77	14.58	15.39	18.40	22.91
84	14.58	15.39	17.52	19.27	23.90
90	15.39	17.52	18.40	22.91	24.90
96	17.52	18.40	21.91	23.90	40.56

RECOMMEND CROSSBAR BELOW DARK LINE

ADD 2.00 FOR WICKET	ADD 4.00 FOR DOUBLE WICKET
---------------------	----------------------------



Lic.#223-02 TE-SC-OC-2520CQ

4625 CHENNAULT BEACH RD. ■ MUKILTEO, WA 98275

(206) 623-6141 ■ (425) 347-0947 ■ (206) 622-3497 ■ Fax (206) 622-6933

PET / SUN MESH ADD ON

NET PRICES

	36	48	60
24	15.30	18.36	21.42
30	16.83	19.89	22.95
36	18.36	21.42	24.48
42	19.89	22.95	26.01
48	21.42	24.48	27.54
54	22.95	26.01	29.07
60	24.48	27.54	36.24
66	26.01	29.07	38.05
72	27.54	36.24	39.86
78	29.07	38.05	51.20
84	36.24	39.86	53.42
90	38.05	51.20	55.65
96	48.97	53.42	89.89

RECOMMEND CROSSBAR BELOW DARK LINE

ADD 3.00 FOR WICKET	ADD 6.00 FOR DOUBLE WICKET
---------------------	----------------------------



Lic. #223-02 TE-SC-OC-2520CQ

4625 CHENNAULT BEACH RD. ■ MUKILTEO, WA 98275

(206) 623-6141 ■ (425) 347-0947 ■ (206) 622-3497 ■ Fax (206) 622-6933

ALUMINUM MESH ADD ON

NET PRICES

	24	30	36	48	60
24	13.63	15.34	17.04	20.45	23.86
30	15.34	17.04	18.74	22.15	25.56
36	17.04	18.74	20.45	23.86	27.26
42	18.74	20.45	22.15	25.56	28.97
48	20.45	22.15	23.86	27.26	30.67
54	22.15	23.86	25.56	28.97	32.38
60	23.86	25.56	27.26	30.67	41.40
66	25.56	27.26	28.97	32.38	43.47
72	27.26	28.97	30.67	41.40	45.54
78	28.97	30.67	32.38	43.47	58.79
84	30.67	32.38	41.40	45.54	61.34
90	32.38	41.40	43.47	58.79	63.90
96	41.40	43.47	56.23	61.34	97.66

RECOMMEND CROSSBAR BELOW DARK LINE

ADD 4.00 FOR WICKET	ADD 8.00 FOR DOUBLE WICKET
---------------------	----------------------------



Lic.#223-02 TE-SC-OC-2520CQ

4625 CHENNAULT BEACH RD. ■ MUKILTEO, WA 98275

(206) 623-6141 ■ (425) 347-0947 ■ (206) 622-3497 ■ Fax (206) 622-6933

ALLERGY / VIRUS GUARD MESH ADD ON

NET PRICES

	24	30	36	48	60
24	16.32	18.36	20.40	24.48	28.56
30	18.36	20.40	22.44	26.52	30.60
36	20.40	22.44	24.48	28.56	32.64
42	22.44	24.48	26.52	30.60	34.68
48	24.48	26.52	28.56	32.64	36.72
54	26.52	28.56	30.60	34.68	38.76
60	28.56	30.60	32.64	36.72	50.40
66	30.60	32.64	34.68	38.76	52.92
72	32.64	34.68	36.72	50.40	55.44
78	34.68	36.72	38.76	52.92	66.24
84	36.72	38.76	50.40	55.44	69.12
90	38.76	50.40	52.92	66.24	72.00
96	50.40	52.92	63.36	69.12	84.24

RECOMMEND CROSSBAR BELOW DARK LINE

ADD 6.00 FOR WICKET	ADD 12.00 FOR DOUBLE WICKET
---------------------	-----------------------------



Lic.#223-02 TE-SC-OC-2520CQ

4625 CHENNAULT BEACH RD. ■ MUKILTEO, WA 98275

(206) 623-6141 ■ (425) 347-0947 ■ (206) 622-3497 ■ Fax (206) 622-6933

BRONZE WIRE MESH ADD ON

NET PRICES

	36	48	60
24	28.32	33.98	39.65
30	31.15	36.82	50.94
36	33.98	47.54	63.46
42	44.15	50.94	67.42
48	47.54	63.46	71.39
54	50.94	67.42	75.35
60	54.34	71.39	79.32
66	57.73	75.35	96.64
72	71.39	79.32	101.24
78	75.35	96.64	105.85
84	79.32	101.24	135.94
90	96.64	105.85	141.60
96	101.24	110.45	147.26

RECOMMEND CROSSBAR BELOW DARK LINE

ADD 8.00 FOR WICKET	ADD 16.00 FOR DOUBLE WICKET
---------------------	-----------------------------



Lic. #223-02 TE-SC-OC-2520CQ

4625 CHENNAULT BEACH RD. ■ MUKILTEO, WA 98275

(206) 623-6141 ■ (425) 347-0947 ■ (206) 622-3497 ■ Fax (206) 622-6933

FLAT WINDOW SCREEN HARDWARE CODES

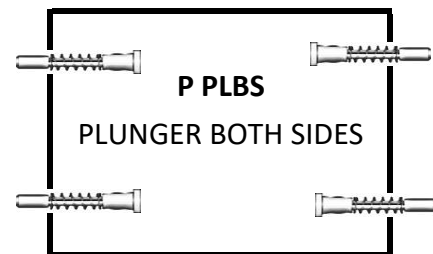
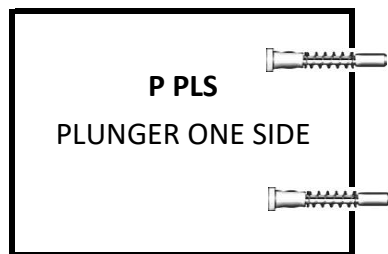
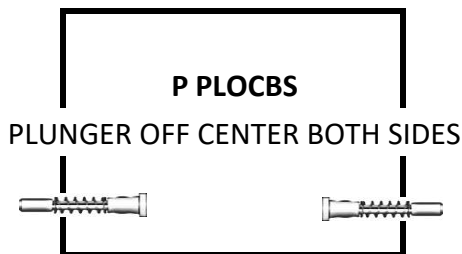
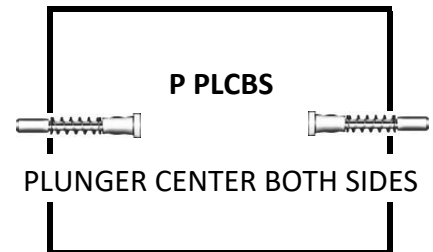
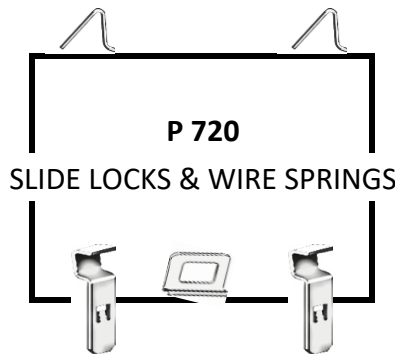
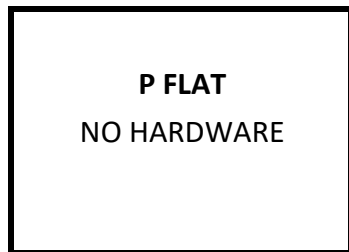
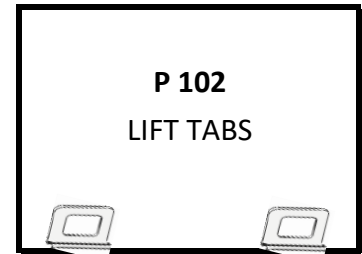
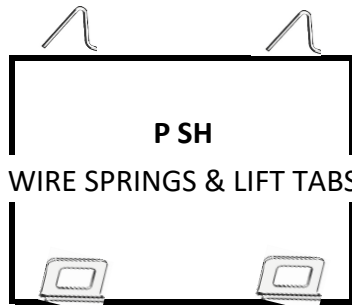
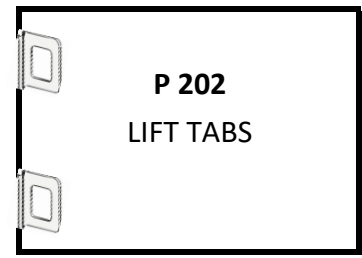
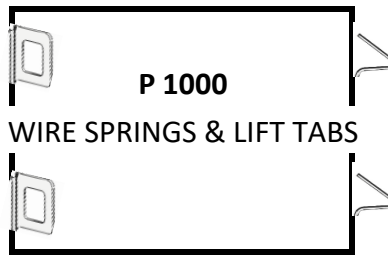
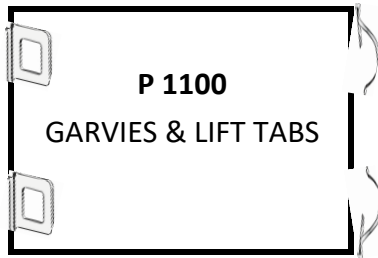



Lic.#223-02 TE-SC-OC-2520CQ

4625 CHENNAULT BEACH RD. ■ MUKILTEO, WA 98275

(206) 623-6141 ■ (425) 347-0947 ■ (206) 622-3497 ■ Fax (206) 622-6933

FRAME, MESH, MISC. SCREEN CODES

FRAME THICKNESS:

4	1/4" FRAME
5	5/16" FRAME
3	3/8" FRAME
7	7/16" FRAME
1	1" FRAME
LP-5	5/16 LIP FRAME
LP-7	1/2 LIP FRAME

FRAME COLOR:

WH	WHITE
GR	GRAY
AL	ALMOND
AD	ADOBE
TN	TAN
CY	CLAY
BR	BRONZE
DB	DARK BRONZE
BK	BLACK
TC	TRUTH CLAY

SCREEN MESH OPTIONS:

BF	BLACK FIBERGLASS
GF	GRAY FIBERGLASS
UV	ULTRAVUE
PS	PET SCREEN
A	BRITE ALUMINUM
BA	BLACK ALUMINUM
SS	SUN SCREEN
SX	SUN TEX
BW	BRONZE WIRE
ST	STAINLESS STEEL
AG	ALLERGY GUARD
VG	VIRUS GUARD

MISC.:

ETC	END TO CENTER
CBAR	CROSS BAR
PL	PLUNGER
CL	CENTER LINE